

DESCRIPTION



SPECIFICATIONS

MAX GPM	3.0	MAX LMP	11.4
MAX PSI	3000	MAX BAR	207
POWER EBHP	6.2	BORE DIA. MM	18
STROKE MM	9.2	WEIGHT LBS	18
MAX TEMP	140°	OIL CAPACITY	13.35oz
INLET THREAD	1/2" F	DISCHARGE THREAD	3/8" F

DIMENSIONS

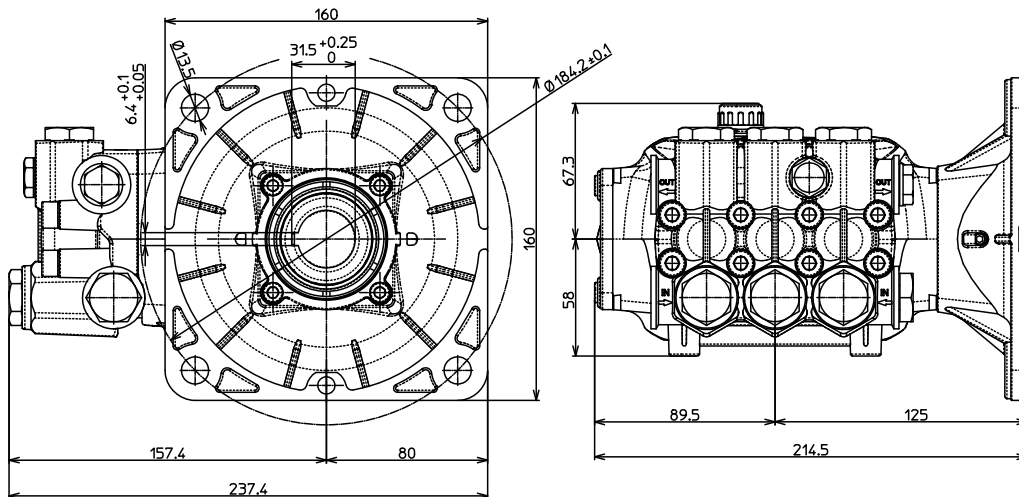

Measurements are - mm

FEATURING

Manifold: High strength forged brass for long term use.

Bolts: Eight 6mm.

Plungers: NEW Ceramic Plungers, thicker wall to help prevent thermal shock.

Valves: Stainless Steel, valve seat o-ring is side mounted.

Seals: High quality high pressure seals. NEW low-pressure seal with a built in scraper.

Piston Guides: Two piece piston guides.

Drive End: NEW connecting rod with 12% more load surface. Large side cover sight glass, oversized bearing. Rear cover oil drain.

Crankshaft: Forged, precision ground.